

VREMYA – CH
Joint Stock Company

MULTICHANNEL FREQUENCY COMPARATOR

VCH-315

Hardware Operation Manual

Software Operation Manual

411146.018OM



| | | | | |
|--------------|--------------|---------------|--------------|--------------|
| Инд. № подл. | Подп. и дата | Взамен инв. № | Инд. № дубл. | Подп. и дата |
| | | | | |

Osharskaya str., 67, Nizhny Novgorod, 603105, Russia
tel./ fax +7 (831) 421-02-94, <http://www.vremya-ch.com>



Contents

| | | |
|----------|--|----|
| 1 | Designation | 3 |
| 2 | Technical specifications..... | 4 |
| 3 | Instrument set composition..... | 5 |
| 4 | Functional diagram of the Comparator VCH-315 | 6 |
| 5 | Operating indicators and connectors..... | 9 |
| 6 | Measurements preparing and testing of the Comparator | 10 |
| 6.1 | Measurements preparing of the Comparator | 10 |
| 6.2 | The Comparator's specification testing..... | 10 |
| 7 | Software overview | 13 |
| 8 | Calculated functions | 14 |
| 9 | Program setup | 15 |
| 10 | Program interface..... | 16 |
| 10.1 | Work area, window "Channel status" | 16 |
| 10.2 | Menu "File"..... | 18 |
| 10.2.1 | "Find record" | 18 |
| 10.2.2 | "Open" – open window "Select data to be watched" | 19 |
| 10.2.2.1 | Select channels | 20 |
| 10.2.2.2 | Select date of record..... | 20 |
| 10.2.2.3 | Records selection | 20 |
| 10.2.2.4 | Table of selected records..... | 22 |
| 10.2.2.5 | Control elements | 22 |
| 10.2.3 | Command "Options" | 24 |
| 10.2.4 | Command "Copy" | 24 |
| 10.2.5 | Command "Print" | 24 |
| 10.2.6 | Command "Exit" | 24 |
| 10.3 | Menu "Run" | 25 |
| 10.4 | Menu "Diagrams" | 25 |
| 10.5 | Menu "Window" | 25 |
| 10.6 | Menu "Help" | 26 |
| 10.7 | Control panel..... | 26 |
| 10.7.1 | Control buttons "Run all" and "Stop all" | 26 |
| 10.7.2 | Control buttons "Channel status" and "Open files" | 26 |
| 10.7.3 | Control buttons "Print" and "Copy" | 26 |
| 11 | Diagrams..... | 27 |
| 11.1 | Diagram "Phase difference"..... | 27 |
| 11.2 | Diagram "Relative frequency difference"..... | 28 |
| 11.3 | Diagram "Allan variance"..... | 29 |
| 11.4 | Diagram "Spectrum"..... | 30 |
| 11.5 | Diagram "Allan variance and cross-variance"..... | 31 |
| 11.6 | Diagram properties | 33 |



1 Designation

The frequency comparator VCH-315 (Comparator in text below) is a controlled by Personal Computer multichannel system for frequency instability measuring of standard frequencies 5 or 10 or 100 MHz.

The Comparator can be controlled from IBM/PC through RS-232C and USB type interfaces.

The main applications of the Comparator:

- crystal and quantum frequency standards production and checking,
- time keeping systems,
- scientific measurements.



2 Technical specifications

- 2.1. Input signals – sine form of 5 or 10 or 100 MHz nominal frequency – (0.8 – 1.2) V_{rms} on 50 Ohm load.
- 2.2. Number of measuring channels – 8 (two groups with four tested and one reference inputs).
- 2.3. Measured relative frequency difference in the range $\pm 5.0 \cdot 10^{-9}$.
- 2.4. Averaging time range, τ – from 1 s up to $1 \cdot 10^6$ s.
- 2.5. Frequency difference measurements resolution – $1.0 \cdot 10^{-14}$ s/ τ .
- 2.6. Frequency fluctuations passband, B – (10 \pm 3) Hz.
- 2.7. Settling time – not more 4 h.
- 2.8. Introduced by the comparator frequency instability (*two sample Allan variance*) – $\sigma_y(\tau) = \sqrt{\sigma_m^2(\tau) + \sigma_{ao}^2(\tau)}$, where: $\sigma_m(\tau)$ – main error (“noise floor”, when $\Delta f/f=0$); $\sigma_{ao}(\tau)$ – additional error (spurious phase modulation, when $\Delta f/f \neq 0$).
- 2.9. The main error, $\sigma_m(\tau)$ – not more values given in the table 2.1.

Table 2.1

| Averaging time, τ | Main error, <i>two sample Allan variance</i> |
|------------------------|--|
| 1 s | $1.5 \cdot 10^{-13}$ |
| 10 s | $2.0 \cdot 10^{-14}$ |
| 100 s | $3.0 \cdot 10^{-15}$ |
| 1000 s and more | $5.0 \cdot 10^{-16}$ |

Notes:

1. Introduced by the comparator frequency instability is guaranteed after 4 hours settling time and additional endurance the comparator "under signals" not less than 30 min.

2. Introduced by the comparator frequency instability for averaging times 1000 s and more is guaranteed provided that ambient temperature changes not more than 1 °C/hour.

- 2.11. Additional error, $\sigma_{ao}(\tau)$ – not more $2.0 \cdot 10^{-3} \Delta f/f$.
- 2.12. AC power supply voltage – (198 – 242) V, 50; 60 Hz.
- 2.13. DC power supply voltage – (22 – 32) V.
- 2.14. Power consumption – not more 40 V·A.
- 2.15. Ambient temperature from +5 °C up to +40 °C.
- 2.16. Weight – not more 8 kg.
- 2.17. Dimensions (W×H×D) – 483×140×370 mm.



3 Instrument set composition

Comparator set composition is given in the table 3.1.

Table 3.1

| № | Model and designation | Quantity |
|----------|---|-----------------|
| 1. | Multichannel frequency comparator VCH-315 | 1 |
| 2. | Power connecting cord | 1 |
| 3. | Interconnecting cable 685670.154 | 4 |
| 4. | Interconnecting cable 685670.154-01 | 2 |
| 5. | BNC connector | 2 |
| 6. | Multichannel frequency comparator VCH-315 Hardware Operation Manual, Software Operation Manual 411146.018OM | 1 |
| 7. | Multichannel frequency comparator VCH-315 Installation CD | 1 |
| 8. | Interface RS-232C cable 685670.026 | 1 |
| 9. | Interface cable USB 2.0 AM/BM-1.8M | 1 |
| 10. | DC power connector 2PMT14 | 1 |



4 Functional diagram of the Comparator VCH-315

Simplified scheme of the Comparator is shown in Fig. 4.1.

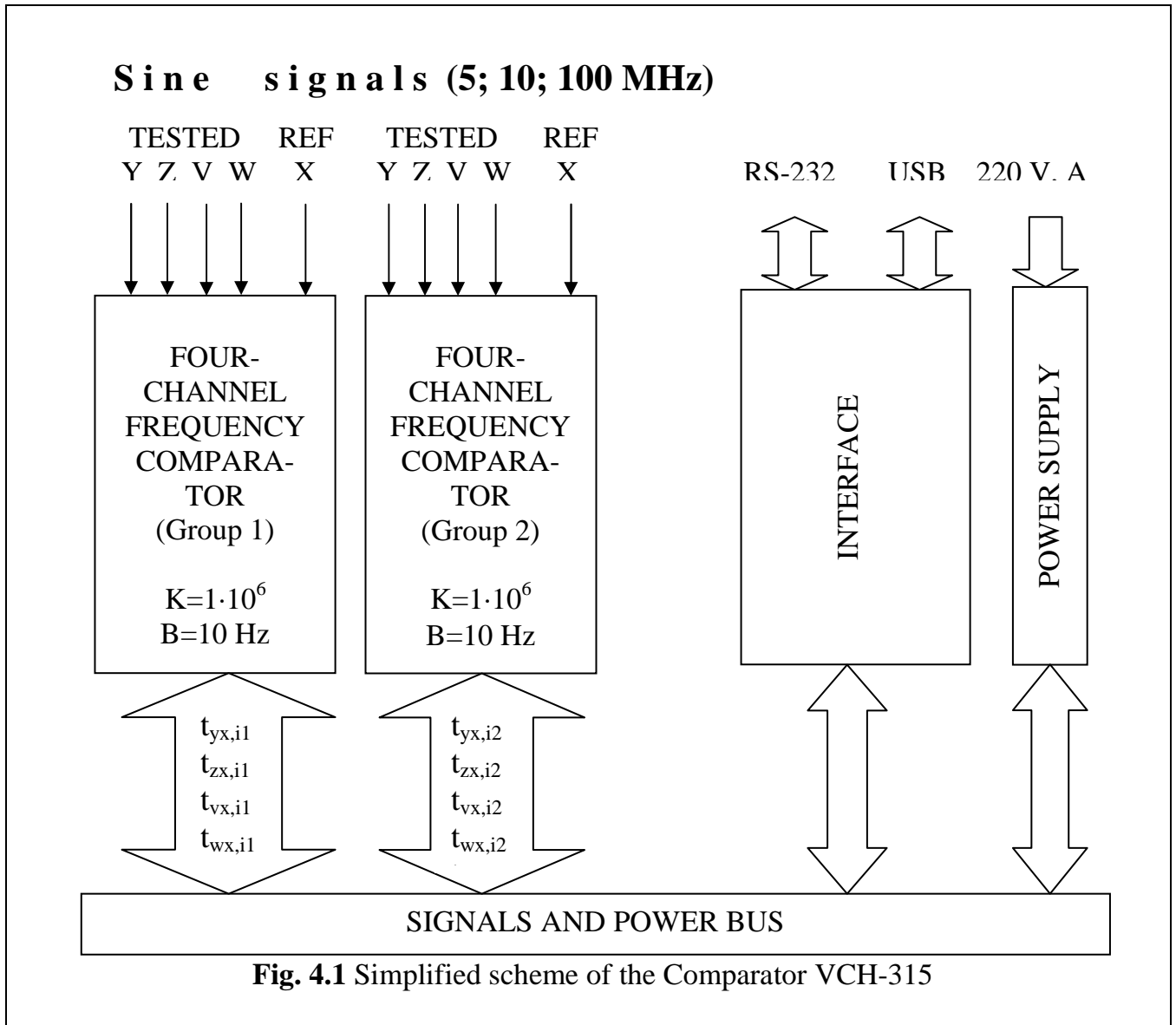

The Comparator VCH-315 contains two identical four-channel frequency comparator modules, which allow to measure sinusoidal signals, signal processor module with RS-232C and USB interfaces, and power supply module.

Four-channel comparator (see Fig. 4.2) has four inputs for analyzed signals and one input for reference signal. It consists of four RELATIVE FREQUENCY DIFFERENCE MULTIPLIER (RFDM) modules with multiplication coefficient $K=1 \cdot 10^6$, and FOUR-CHANNEL TIME RECORDER with resolution 10 ns.

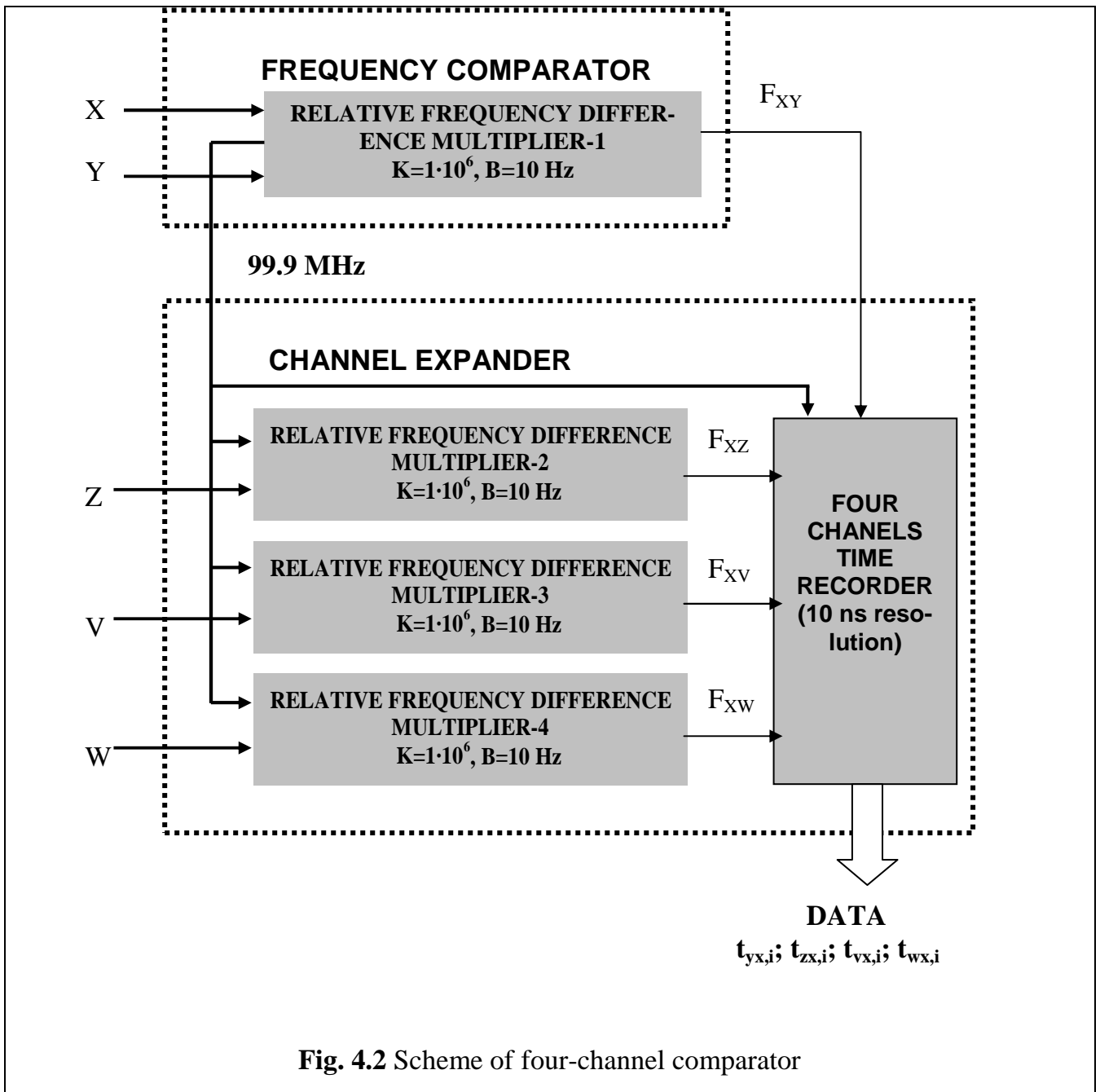

Fig. 4.2 Scheme of four-channel comparator

Output of multiplier module is pulse signal (frequency of this signal is close to 1 Hz). Frequency F of this signal contains information about frequency difference between analyzed signal f_y (or f_z, f_v, f_w) and f_x :

$$F_{xy} [\text{Hz}] = 1 + K \cdot (f_y - f_x) / f_x . \tag{4.1}$$

Here $K = 1 \cdot 10^6$ – multiplication coefficient.

Effective passband for frequency fluctuations is $B=10$ Hz.

Pulse signals from multiplier modules go to the inputs of FOUR CHANNEL TIME RECORDER, which gives on the output digitized values of time moments $t_{yx}, t_{zx}, t_{vx}, t_{wx}$ containing information about corresponding phase differences. Fig. 4.3 describes forming process of digitized phase difference signals.

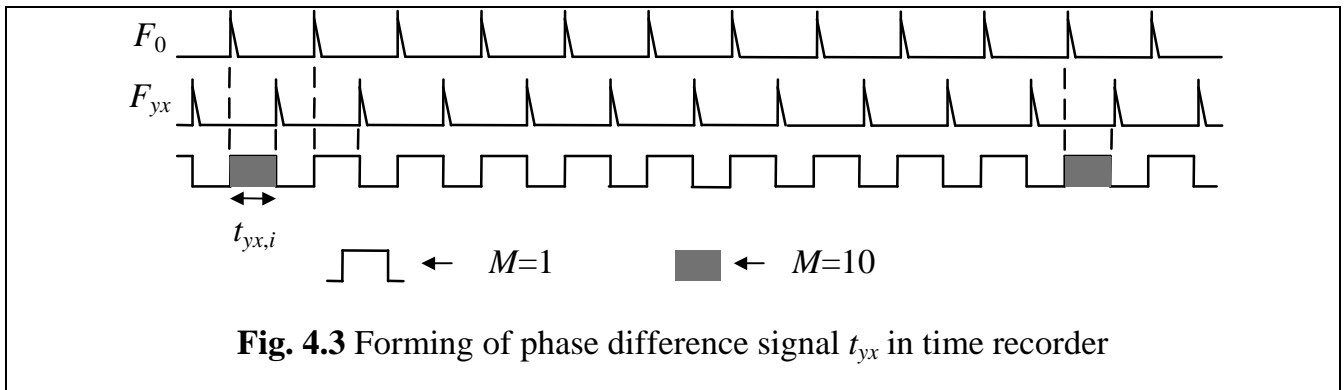

In Fig. 4.3 F_0 is reference 1 PPS signal, formed in time recorder from signal 99.9 MHz, which is synchronized to the reference signal X by means of PLL.

Compared pulse signals are shifted in time on half of period (0.5 second) at the beginning of measurement.

Time recorder updates output data every second. These data are processed by Program and stored on hard drive. Program can save decimated data with coefficient $K_{dec} = 1, 10, 100$ or 1000 (see Subsection 10.1).



5 Operating indicators and connectors

On the front panel of the Comparator there is power indicator only.

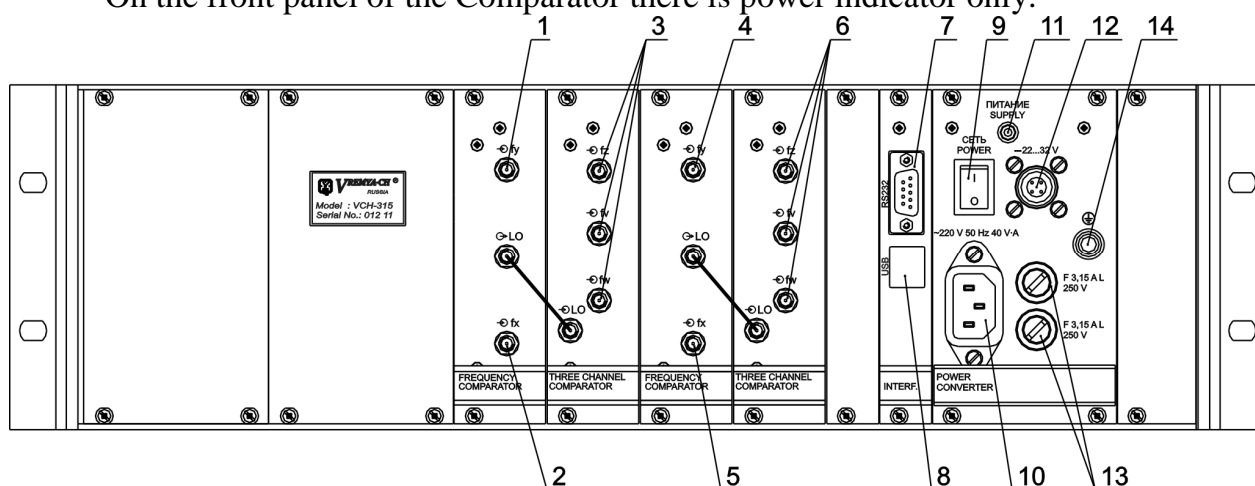

Fig. 5.1 Connectors and indicators on the rear panel

| Position number (Fig.5.1) | Name | Designation |
|---------------------------|--------------------------------------|---|
| 1 | $\ominus fy$ | Tested signal input (second group, channel 5) |
| 2 | $\ominus fx$ | Reference signal input (second group) |
| 3 | $\ominus fz, \ominus fv, \ominus fw$ | Tested signal inputs (second group, channels 6,7,8) |
| 4 | $\ominus fy$ | Tested signal input (first group, channel 1) |
| 5 | $\ominus fx$ | Reference signal input (first group) |
| 6 | $\ominus fz, \ominus fv, \ominus fw$ | Tested signal inputs (first group, channels 2,3,4) |
| 7 | RS-232C | PC interface RS-232C |
| 8 | USB | PC interface USB |
| 9 | ЦЕПЬ POWER | AC power switch |
| 10 | 220 V, 50 Hz, 40 V·A | AC power connector |
| 11 | ПИТАНИЕ SUPPLY | Power voltage indicator |
| 12 | $\text{---} 22...32 \text{ V}$ | DC power connector |
| 13 | F 3,15 A L | Fuse holders |
| 14 | \oplus | Safety grounding connector |



6 Measurements preparing and testing of the Comparator

6.1 Measurements preparing of the Comparator

Remember that any device placed near the Comparator and radiating signal with frequency close to the working frequency of the Comparator is a source of additional measurement error.

Connect Comparator to PC by RS-232 interface cable when Comparator switched off. When you use USB interface there is no need to switch off Comparator.

Warm up the Comparator not less than 4 hours.

The signal at « \ominus fx» input of first group must always be connected. The signal at « \ominus fx» input of second group should be connected to the case when You are going to use the second group.

To provide the Comparator with DC power supply you should make DC power connecting cord using DC power connector 2PMT14 Comparator set composition (see Fig. 6.2).

6.2 The Comparator's specification testing

6.2.1 Main error measuring.

Before measuring you may check measurement error for each channel. To make this test it is necessary to supply reference (fx) and tested (fy, fz, fv, fw) inputs of the Comparator by the same signal (see Fig 6.1). Then you should start frequency instability measuring and find instability, introduced by tested channel.

6.2.2 Additional error measuring.

To check additional error due to frequency difference of tested signals it is necessary to supply reference (fx) and three tested (fz, fv, fw) inputs by the same signal, and to supply forth (fy) tested input by the signal with relative frequency difference $\Delta f/f_0 = (4.8 - 4.9) \cdot 10^{-9}$ (see Fig. 6.3). Start measuring for (200 ± 10) s and measure Allan variance $\sigma(1\text{ s})$ for channels 2, 3, 4, 6, 7, 8.

Reconnect signal cables from tested inputs « \ominus fy» to inputs « \ominus fz» of first and second group. Start measuring for (200 ± 30) s and measure Allan variance $\sigma(1\text{ s})$ for channels 1, 3, 4, 5, 7, 8.

Reconnect signal cables from tested inputs « \ominus fz» to inputs « \ominus fv» of first and second group. Start measuring for (200 ± 30) s and measure Allan variance $\sigma(1\text{ s})$ for channels 1, 2, 4, 5, 6, 8.

Reconnect signal cables from tested inputs « \ominus fv» to inputs « \ominus fw» of first and second group. Start measuring for (200 ± 30) s and measure Allan variance $\sigma(1\text{ s})$ for channels 1, 2, 3, 5, 6, 7.

Measured value $\sigma(1\text{ s})$ should be not more $2.0 \cdot 10^{-3} \Delta f/f_0$.



Attention! The torque for SMA connector must be in the range (0.8 – 1.1) N·m.

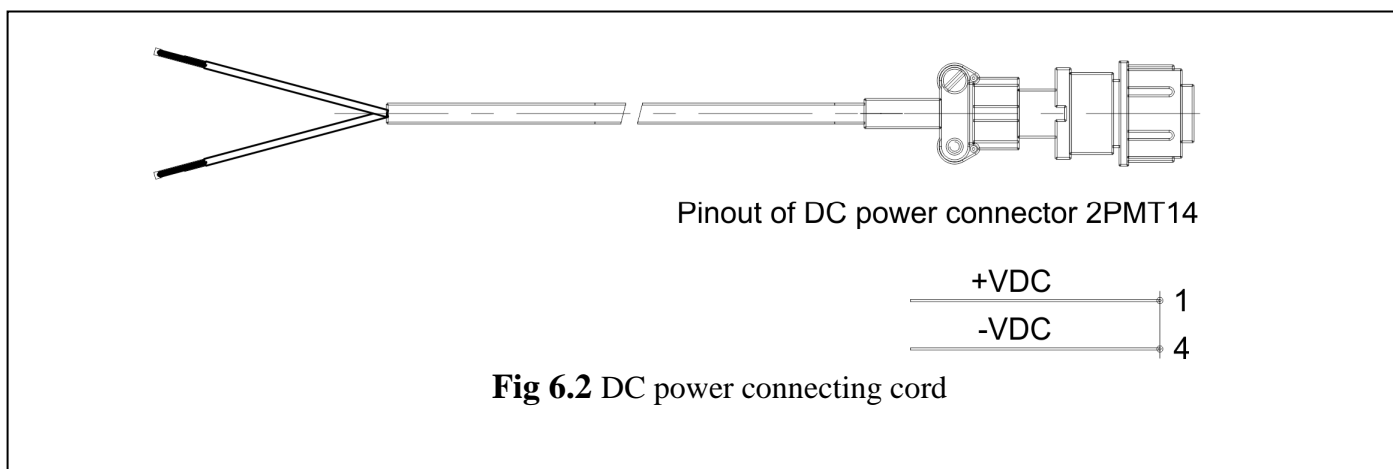
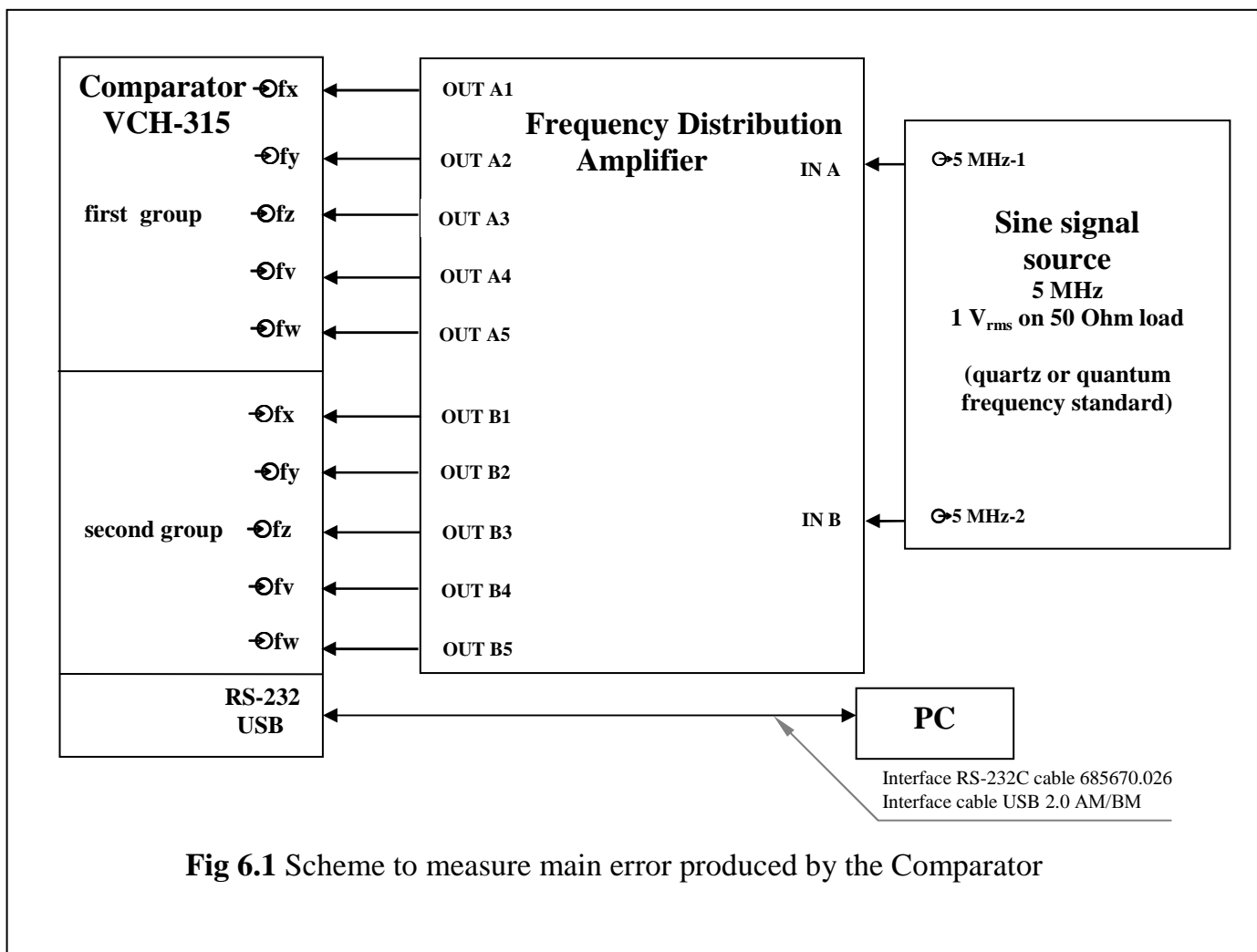

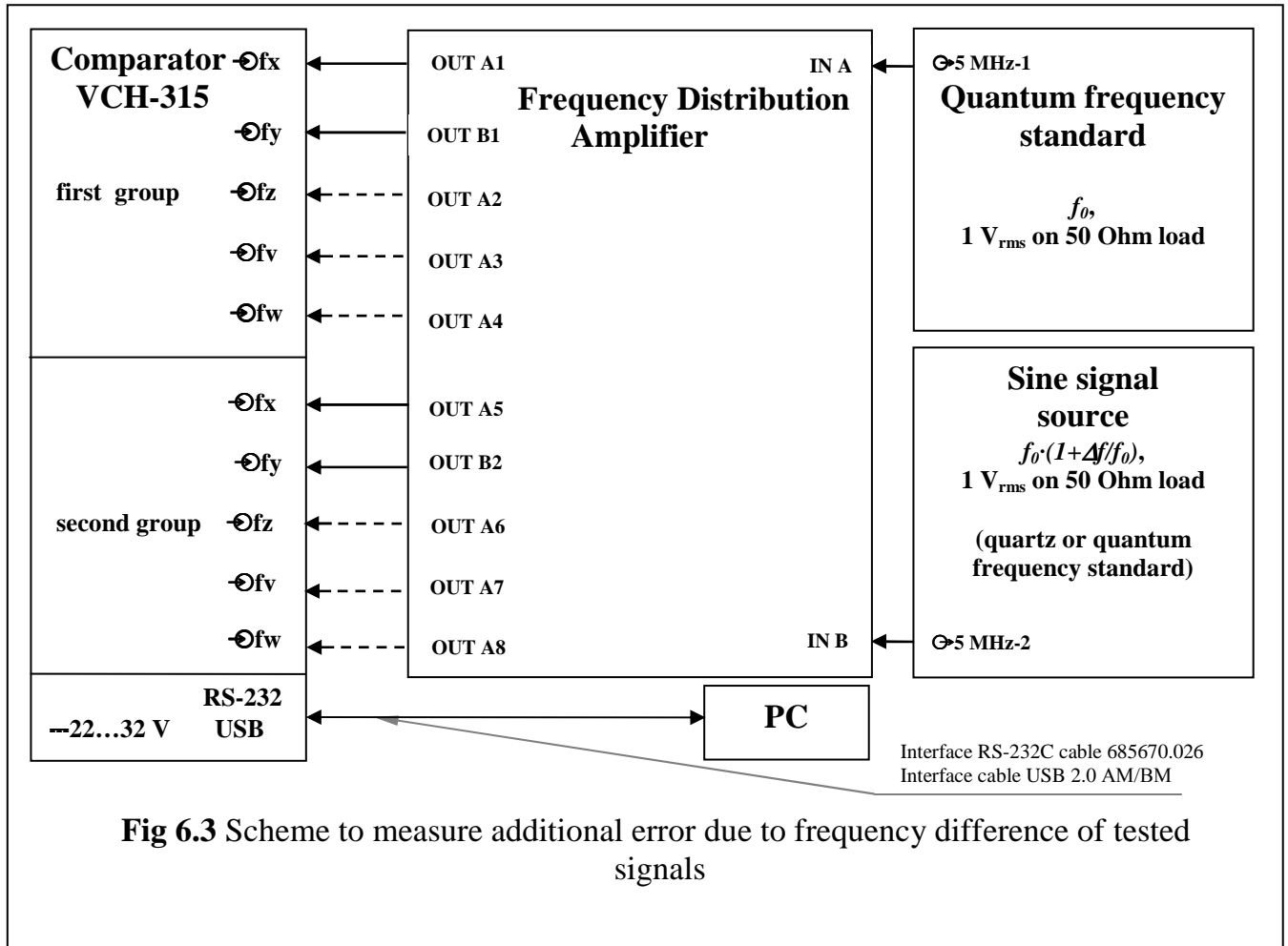

Fig 6.3 Scheme to measure additional error due to frequency difference of tested signals



7 Software overview

Program for Control of Multichannel Frequency Comparator VCH-315 (Program in text below) allows to process and store data of frequency instability measurements.

System requirements: Intel Pentium-IV, 2 GHz, 512 Mb RAM, Windows XP/Vista/7.

It is strongly recommended to select in “Control Panel>Regional and Language Options>Regional Options>Standards and formats” the item “English (United States)”.

Comparator can be connected to Personal Computer (PC) with Program installed via RS-232C or USB interface. USB works as virtual serial interface.

If Comparator is connected to a PC via USB interface DO NOT DISCONNECT Comparator when Program is working!

Program allows:

- reading and storing measured data from the Comparator,
- calculating Allan variance and mean frequency difference,
- presenting of measurement results and calculated functions in diagrams,
- printing diagrams.



8 Calculated functions

Initial data for all calculated statistical functions are digitized phase differences t_{yx} , which are obtained from time recorder module of Comparator (see Section 4).

To get real phase difference between signals Y and X we should divide t_{yx} on the coefficient of relative frequency difference multiplier ($K = 10^6$):

$$\Delta_{yx,i} = \frac{1}{K} t_{yx,i} , \quad (8.1)$$

Here i is sample number (total number of time samples is N).

After that we can calculate relative frequency differences for compared signals on the interval $\tau = M$ seconds:

$$y_{yx,i}^M = \frac{1}{\tau} (\Delta_{yx,M(i+1)} - \Delta_{yx,Mi}) , \quad (8.2)$$

In the text below we omit upper index M , implying that frequency differences are measured on the interval M seconds.

Program allows calculating current frequency variations:

$$\sigma_{yx,i} = y_{yx,i+1} - y_{yx,i} , \quad (8.3)$$

Average frequency difference on the interval $(N-1) \cdot \tau$ seconds is calculated as follows:

$$y_{yx}^N = \frac{1}{N-1} \sum_{i=1}^N y_{yx,i} = \frac{1}{(N-1)\tau} (\Delta_{yx,N\tau} - \Delta_{yx,0}) . \quad (8.4)$$

Root mean square two-sample relative frequency variation or Allan variance is calculated by the following formula:

$$\sigma_{yx}^N = \sqrt{\frac{1}{2(N-2)} \sum_{i=1}^{N-2} (\sigma_{yx,i})^2} . \quad (8.5)$$

Note that in formula (8.5) in denominator there is term $(N-2)$ because the number of frequency variances $\sigma_{yx,i}$ is $(N-2)$ if the number of phase samples $\Delta_{yx,i}$ is N .

In the Program, Allan variance is marked as Var2.

The Program allows calculating Allan variances for single signals by means of cross-variance formulae:

$$\sigma_x^N = \sqrt{\frac{1}{2(N-1)} \sum_{i=1}^{N-1} \sigma_{y1x,i} \sigma_{y2x,i}} . \quad (8.6)$$

In (8.6) σ_x^N – estimation of Allan variance for signal x , $\sigma_{y1x,i}$, $\sigma_{y2x,i}$ – relative frequency variances for pairs of signals $y1 - x$ and $y2 - x$, respectively.



9 Program setup

See program requirements in Chapter 7.

Instrument set composition contains Installation CD with installation files and driver. Installation program will be run automatically after CD is inserted in CD-drive. If installation program is not started, launch file setup.exe from the root directory on CD manually. Installation program creates an icon “VCH-315” on desktop and corresponding item in menu “Start>Programs”.

The driver for Comparator must be installed before using the USB interface. This driver creates virtual serial port in Windows[®] when instrument is connected to a PC via USB cable, for instance “USB Serial Port (COM8)”. To install driver it is necessary to connect Comparator to a PC via USB cable and switch on Comparator. After that, if the driver was not installed previously, Windows[®] finds new hardware “USB High Speed Serial Converter” (“USB ↔ Serial”) and runs New Hardware Wizard. You should follow standard procedure for driver installation, driver files are in directory “Driver” on Installation CD. If New Hardware Wizard is launched again after the end of installation procedure, it is necessary to repeat driver installation. Warnings about compatibility of the driver with Windows[®] must be ignored.



10 Program interface

Program interface has standard Windows application style. Fragment of the main window of Program is shown in Fig. 10.1.

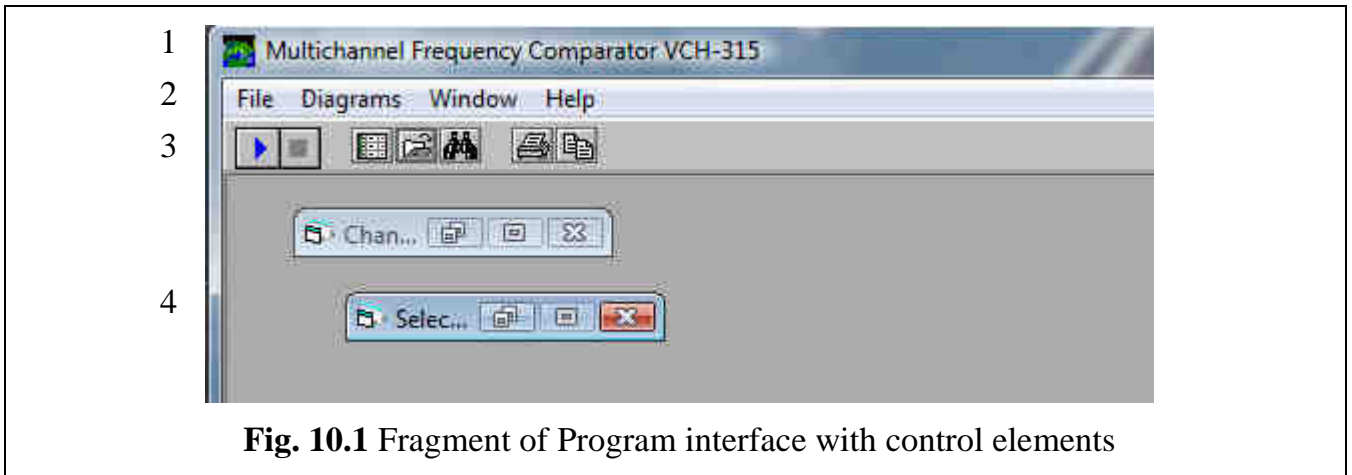

Fig. 10.1 Fragment of Program interface with control elements

Main window contains the following elements:

1. Window caption.
2. Menu.
3. Control elements panel.
4. Work area.

Elements' assignment and its functions are described below.

10.1 Work area, window “Channel status”

Work area of Program interface is to contain dialog windows and diagrams, which can be minimized to icons, maximized to the size of work area or can be closed. The only window which cannot be closed if Program is loaded is “Channel status” window, which is presented in Fig. 10.2.

“Channel status” window is a dialog window, which contains table. Number of rows in the table is the number of input channels for tested signals of Comparator and equals 8.

Table has 8 columns:

- 1) “Channel” – channel number
- 2) “Lock” – channel locking
- 3) “Run/Stop” – start / finish processing and saving data of corresponding channel
- 4) “Reference” – name of reference signal.
- 5) “Tested” – name of tested signal.
- 6) “Kdec” – decimation coefficient for analyzed data.
- 7) “N” – number of time samples have been read.
- 8) “Diagram” – field for control of diagrams in each channel.

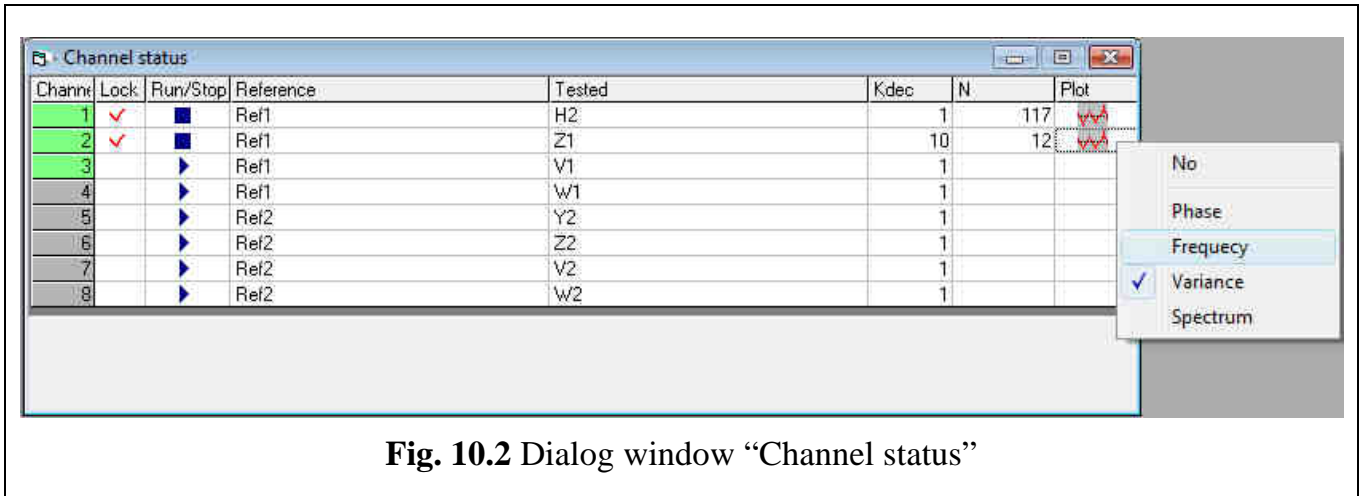

Fig. 10.2 Dialog window “Channel status”

Width of columns can be changed by User.

First column cannot be modified by User, it indicates channel numbers. Green color of a cell in this column means that signal is present in corresponding channel of Comparator.

Cells in second column indicate whether corresponding channel is locked (“v”) or not. Locking of a channel means that data processing in the channel cannot be stopped by User. To change locking status of a channel it is necessary to click mouse on the cell in second column in the row for this channel.

Cells in third column are intended for running or stopping data processing in channels. To run or to stop data processing in a channel it is necessary to click on the cell for this channel. Symbol “■” (Stop) informs that data processing is in progress, symbol “▶” (Run) informs that data are not analyzed and User can start data processing by mouse click on this symbol.

Fourth column “Reference” contains names of signal f_x , which is used as reference signal in FOUR-CHANNEL FREQUENCY COMPARATOR module (see Chapter 2). Name can be any text containing not more than 128 symbols. To change the name – click on the cell and enter new name using keyboard.

Fifth column “Tested” contains names of tested signals (f_y) (name can be any text with length not greater than 128 symbols.).

Next column shows values of decimation coefficients for each channel. To change decimation coefficient it is necessary to click on the cell for required channel and select value from the list appearing in the bottom of “Channel status” window. Possible values of decimation coefficient are 1, 10, 100 and 1000. Data are decimated before writing on a hard drive. Note, that the value of decimation coefficient confines the minimum averaging time for Allan variance calculation.

It is recommended to select the maximum possible for your aim value of decimation coefficient. It reduces sizes of files stored on hard drive and decrease time of data processing and statistical functions calculation.

The next column shows the numbers of samples “N” have been read for each channel. If data processing is run then number of samples is increased every τ seconds, where $\tau = K_{dec} -$



decimation coefficient. Update of this column is paused in case of column “Reference” or column “Tested” is open for editing (but time samples reading and storing are not paused).

The last column “Diagram” is to open and activate diagrams of phase differences, relative frequency differences, Allan variances and spectra (see Section 6 for more details about diagrams). Click on the cell of required channel in this column and select the diagram you need from the pop-up menu, which is shown in Fig. 10.2. Selected diagrams are opening in separate windows. To stop updating of the diagram you should remove corresponding tick in pop-up menu. If you select item “No” in pop-up menu then updating of all diagrams will be stopped.

10.2 Menu “File”

This menu contains commands:

- “Find record”,
- “Open” – open window “Select data to be watched”,
- “Options” – select serial port number to connect to Comparator,
- “Copy” – copy active diagram to clipboard,
- “Print” – print active diagram,
- “Exit” – close Program.

10.2.1 “Find record”

Clicking on this item of menu “File” or icon  opens dialog window “Search for records”, shown in Fig. 10.3.

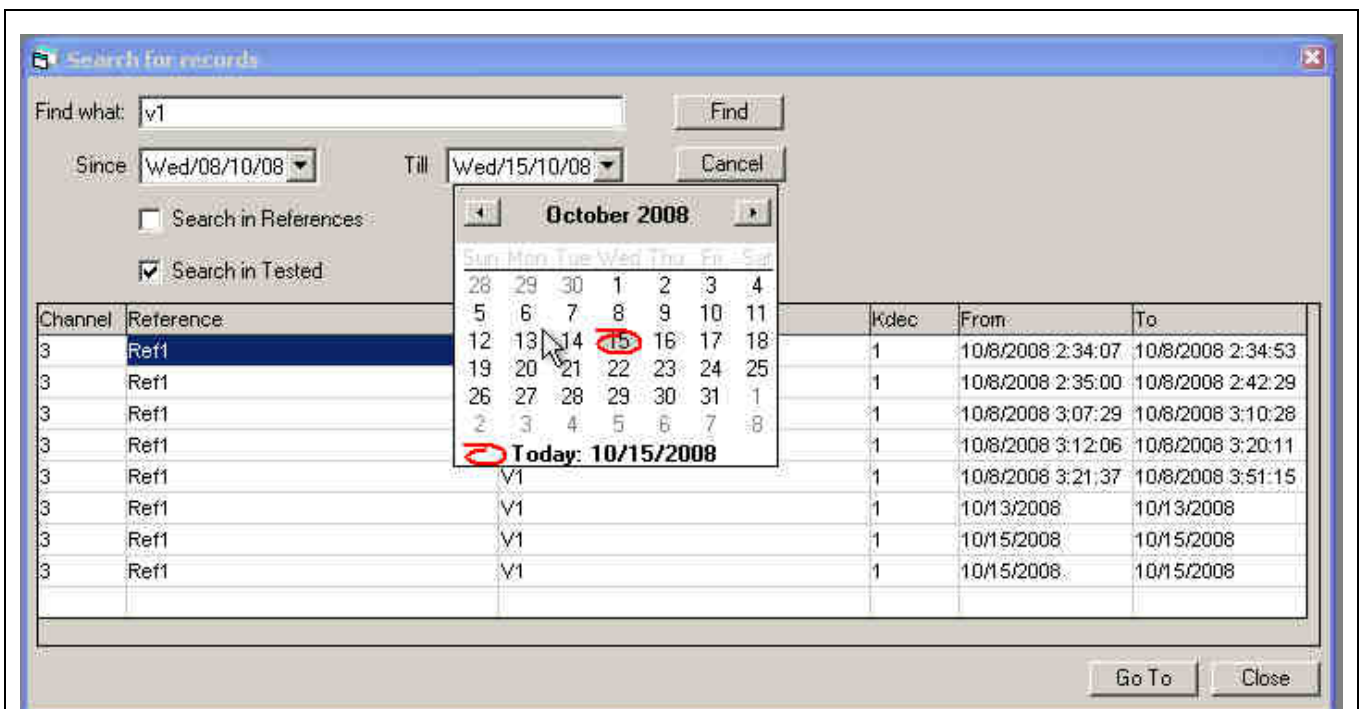

Fig. 10.3 Example of dialog window “Search for records”



Using this window you can find record of measurements by name of tested signal or by name of reference signal in selected interval of dates. Name of tested signal or reference is edited in the field “Find what”. Results of search are printed in the table. If you select one or several found records from the table and click on the button “Go To” then the window “Select data to be watched” containing selected records will be opened.

10.2.2 “Open” – open window “Select data to be watched”

To open window “Select data to be watched” (see Fig. 10.4) you should select item “Open” from menu “File” or to click on button  on the control panel (see Fig. 10.1).

File with time samples of phase differences is saved in subdirectory\samples of the main directory contains files of Program.

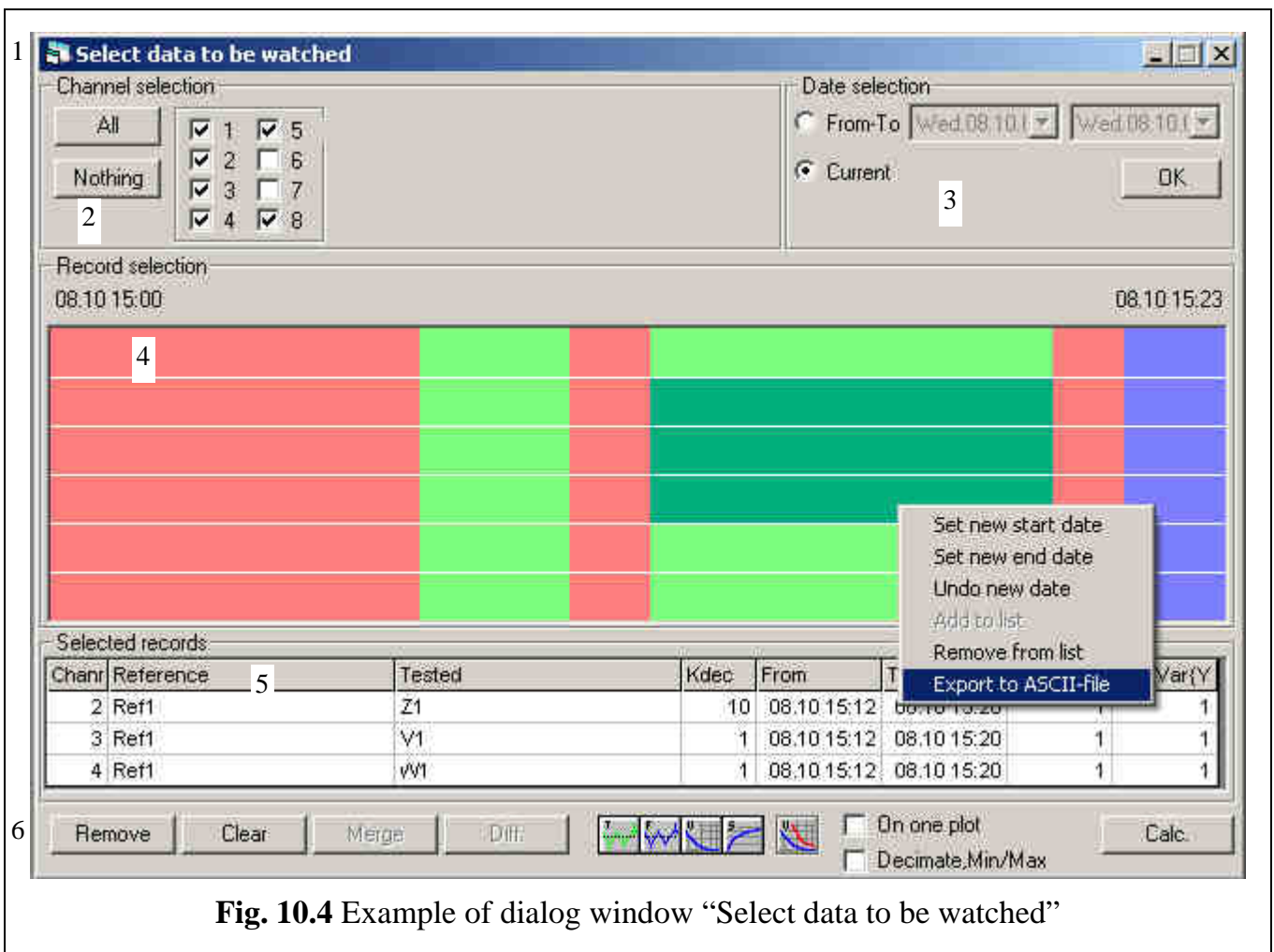

Fig. 10.4 Example of dialog window “Select data to be watched”

Window “Select data to be watched” contains the following fields.

1. Standard for Windows applications caption field.
2. Channel selection field.
3. Dates selection field.
4. Record selection diagram.
5. Table of selected records.
6. Field of control elements.



These fields are described below.

10.2.2.1 Select channels

To select channels to be watched you should mark required channel numbers (1 – 8). To select all channels you may click on button “All”, to deselect all channels – click on button “Nothing”.

After that you can operate with the next field.

10.2.2.2 Select date of record

Program allows two ways of record selection:

- For period defined by User;
- For current moment (since the beginning of current day till the current moment).

To view data for specified period you should activate button “From-To” and select begin and end dates. Selected time period starts from 00:00 of begin date and finishes at 23:59:59 of end date.

Previously defined dates in calendars “From” and “To” are marked by gray color. Current date is counterred by red line.

To view current records you should click on button “Current”.

After selection of dates click on button “OK” and switch to the next field.

Activation of button “OK” leads to updating of “Record selection” field always.

10.2.2.3 Records selection

Field for records selection looks like diagram: channel records versus time. The number of rows corresponds to the number of selected channels.

Date and time of beginning and end of watched period is presented on the top of the diagram (beginning on the left and end on the right).

Each row can contain several pieces of different colors. Colors mean the following

- Red – there is no record on this interval.
- Bright green – there is record on this interval.
- Blue – the interval contains record which is in progress.
- Dark green – record for this interval is put into the list for selected records (field “5”).

Placement of mouse pointer on a row of the diagram leads to representation of context-sensitive prompt, which contains date, time, channel number, tested signal and reference names (if there is record on time moment corresponding to pointer position).



To analyze selected record place mouse pointer on corresponding part of the diagram, then click right mouse button. Context-sensitive menu will be opened. This menu contains the following commands:

- Set new start date
- Set new end date
- Undo new date
- Add to list
- Remove from list
- Export to ASCII-file.

The list of available items depends on the previous actions for selected record. For example, command “Undo new date” will be available only if start date or end date is changed for this record.

- Commands: Set new start date, Set new end date, Undo new date

The moment of time of beginning and end of watched period can be changed by commands “Set new start date” and “Set new end date”. Selected time moment is defined by position of mouse pointer, which must be placed on any row of the diagram.

Therefore, to change the boundary of period of time viewed in the diagram, click right mouse button on required point of the diagram. Then use pop-up menu and select “Set new start date” or “Set new end date” depending on what you need in this point. New time moment of begin or end of period watched can be selected as on the interval free of records (red field) as on the interval with record (blue or green field). *For instance, if you select start point on the interval which contains record, then calculation of statistical characteristics will be for time samples of phases of the record starting from the selected point, not for all record.*

To cancel changes of period watched, click on the item “Undo new date”. Program remembers five last changes.

- Commands: Add to list, Remove from list

Command “Add to list” can be applied to the part of the diagram colored with bright green or blue only (these colors inform that there is record in considered channel, on selected time period). After click on the item “Add to list” selected record is represented in the table “Selected records”. The maximum number of records written to the table is three.

Command “Remove from list” can be applied to the part of the diagram colored with dark green only (this color informs that corresponding record is written to the table “Selected records”). This command removes the record selected from the table.

- Command: Export to ASCII-file

This command realizes export of data of selected record into text file written in ASCII format. Default name of created ASCII-file is “YYMMDD_CC.asc”, where YY, MM, DD, CC are two-digits designation of year, month, day and channel number correspondingly. For example, file 020721_05.asc contains data of the record started in June 21, 2002, for channel number 5.

Default directory for ASCII-files is \data located in the main directory with comparator program installed (this directory can be changed by User).



ASCII-file contains five columns:

1. sample number,
2. date of sample (in format MM:dd),
3. time (in format hh:mm:ss),
4. sample time in seconds (starting from the moment when Comparator was switched on),
5. phase difference in seconds (in format with fixed point: "123.12345678").

10.2.2.4 Table of selected records

Table of selected records is located in the field "5" on dialog window "Select data to be watched", shown in Fig. 10.4. This table contains three rows for records, which can be selected from the diagram "Records selection" (field 4).

Third row can be used for data obtained by subtraction or merging of samples from the records selected in first and second rows of the table. Note that subtraction is carried out for samples in overlapping time moments only. To make subtraction of records placed in first and second rows of the table, click on the button "Diff.". To merge records placed in first and second rows of the table, click on the button "Merge".

Columns of the table contain information about analyzed record: channel number, names of reference and tested signals, decimation coefficient, dates and times of beginning and end of record, limit on maximum relative frequency difference (MaxY) and limit on maximum variation of relative frequency difference (MaxVar{Y}).

It is possible to edit values of two last columns (MaxY, MaxVar{Y}) only. To set a new value, click on the necessary cell, then enter from keyboard new value and click mouse on any other cell.

Limit value is valid for any record put into corresponding row. During calculation of statistical characteristics the values which exceed limits are dropped. If the number of dropped samples exceeds 20% of total samples of the record, then Program will warning about it and will stop data processing.

To view diagrams with statistical characteristics, do the following.

1. Select necessary record by clicking on any cell of corresponding row.
2. Click on the control button, which corresponds to the diagram you need. Control buttons are placed on the field "6" (Fig. 10.4), they are described in the next subsection.

10.2.2.5 Control elements

This field consists of several groups of control elements.

The first group contains buttons which allow controlling records in the table "Selected records".

Activation of control button "Remove" leads to deleting the selected record from the table. By default, the first record in the table is selected. To select record manually click on the corresponding row of the table.

For deletion of all records in the table, click control button "Clear".

Control button "Merge" is intended for merging two records into one. It can be useful in case of occasional short breaks during data input. To merge records it is needed:

- Fill out (using command "Add to list" in pop-up menu) two rows of the table with records which you want to merge.







- Click on the button “Merge”.

After that the third (порядковые числительные используются с артиклями) row of the table will contain record merged.

The last element of first group is button “Diff.”. Activation of this button leads to subtraction of time samples of the record in second row from the time samples of the record in first row of the table. Result of subtraction is put into third row of the table. Compared records must have overlapping time moments. This function allows analyzing statistical characteristics of frequency differences of two tested signals. Note, that it differs from default characteristics, which are calculated for frequency differences between tested and reference signals.

The second group of control elements is intended for calculating and viewing diagrams of statistical functions. This group contains four control buttons.

- **Phase difference diagram** 
- **Relative frequency difference diagram** 
- **Allan variance diagram** 
- **Spectrum of relative frequency difference diagram** 
- **Allan variance cross-variance diagram** 

After activating any of these buttons, Program reads data file, calculates statistical functions for selected time interval, and represents calculated function (which corresponds to activated button) in diagram.

The second button “**Relative frequency difference diagram**” is a bit different from the others. After button activation, Program shows diagram of relative frequency difference which is calculated for averaging time equals to K_{dec} seconds by default, K_{dec} is the decimation coefficient for corresponding record (see Subsection 10.1). User can change averaging time for this function by clicking right mouse button on the control button and selecting value from the pop-up menu by clicking left mouse button. After that, required diagram is plotted.

To enable cross-variance diagram two records for to different channels must be selected. These records should have nonzero overlapping time intervals. It is important to select channels with the same reference signal.

The third group of control elements contains two fields with check-box buttons: “On one plot” and “Decimate, Min/Max”.

If “✓” is selected in the field “On one plot”, then functions for all records placed in the table will be represented on one plot. In this case, number of samples used for statistical functions calculation is selected the same for all records. If selected records have different decimation coefficients then the maximum decimation coefficient will be used in diagrams.

If “✓” is selected in the field “Decimate, Min/Max” and number of samples in selected record is greater than 4000, then diagram “Phase difference” for the record shows 4000 points which are minimum and maximum values of phase differences on decimation interval. Decimation interval depends on the length of initial record. This function allows avoiding the loss of short bursts in phase difference. The loss of bursts can occur in case of usual decimation of data.



The last control element of window “Select data to be watched” is button “Calc.”, which runs calculator of dates. Calculator computes date and time of record by User defined number of time sample counting out from the start date or computes sample number by defined date and time of the sample. Program calculates the field which is free. Calculation takes into account decimation coefficient which can be changed in this window.

10.2.3 Command “Options”

Activation of this command leads to opening dialog window “Options”, see Fig. 10.5. This window allows selecting serial port number to use connection between Comparator and computer via RS-232C or USB interfaces. List of available COM-ports including virtual COM-port for USB connection (see Section 9) is formed by Program automatically, when User clicks on item “Options”.

Program can be used to analyze data previously recorded, when Comparator is disconnected or switched off. To use this regime, it is necessary to select COM0.

If User select new COM-port, which is not COM0, then Program reload is needed.

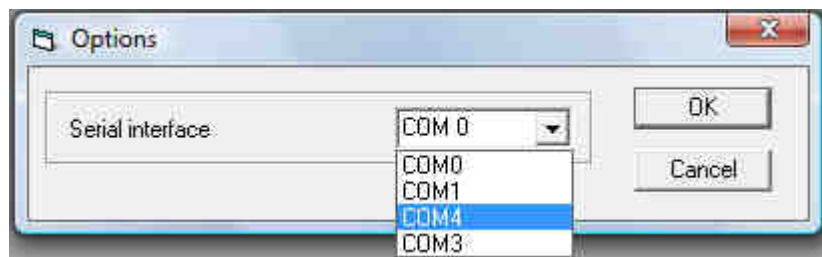



Fig. 10.5. Dialog window “Options”

10.2.4 Command “Copy”

This command allows copying image of active diagram into clipboard of computer. Copied image can be used in Windows applications, for example in MS Word. Command “Copy” of menu “File” is duplicated by control button  placed on panel “3” of main window, see Fig. 10.1.

10.2.5 Command “Print”



Command “Print” in menu “File” is duplicated by button  “Print”, placed on control panel “3” of Program interface, see Fig. 10.1. Clicking on item or button “Print” leads to printing the active diagram.

10.2.6 Command “Exit”

Activation of command “Exit” (menu “File”) closes Program. If data processing is not stopped in some channels when you click “Exit”, then Program warns about it.



10.3 Menu “Run”

Menu “Run” contains two commands: “Run all” and “Stop all”. These commands are duplicated by control buttons  and  placed on panel “3”, see Fig. 10.1 and Subsection 10.7.1.

This menu is replaced by menu “Diagrams” if dialog window “Select data to be watched” is active.

10.4 Menu “Diagrams”

Menu “Diagrams” is placed instead of menu “Run” if dialog window “Select data to be watched” is active.

This menu contains items, which duplicates buttons for diagram plotting, described in Subsection 10.2.2.5. This menu allows selecting types of diagrams and its parameters.

10.5 Menu “Window”

This menu allows controlling Program windows which have been opened. Opened menu “Window” is shown in Fig. 10.6.

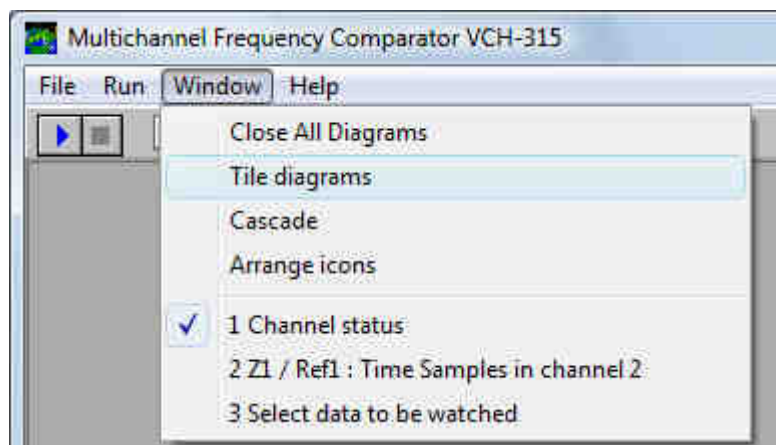

Fig. 10.6 Menu “Window”

Menu “Window” contains four items:

- “Close all diagrams”,
- “Tile diagrams”,
- “Cascade”,
- “Arrange icons”,

and the list of opened windows (windows can be minimized into icons). Symbol “v” means that corresponding window is active at the moment.

Command “Close all diagrams” closes all windows with diagrams. Command “Tile diagrams” adjusts sizes of opened windows with diagrams for non-overlapping covering total area of main window. Command “Cascade” opens all windows and order them in cascade. Command “Arrange icons” orders all icons in main window.



10.6 Menu “Help”

Menu “Help” contains two items: “Content” – content Program help, and “About” – information about the manufacturer and Program version.



There is context-sensitive prompt in Program. To open part of the prompt for Program window you are interested in, activate this window and press F1 button.

Several fields and control elements of the interface have short prompt, which will be opened if mouse pointer is placed on them.

10.7 Control panel

Control panel is placed on the main window of Program interface; it is marked with 3 in Fig. 10.1. Control buttons of the panel are described below.

10.7.1 Control buttons “Run all” and “Stop all”

Activation of button  “Run all” runs data processing in all channels simultaneously. To stop data processing in all channels simultaneously, click on control button  “Stop all”.



10.7.2 Control buttons “Channel status” and “Open files”

Button  “Channel status” activates dialog window “Channel status”, see Fig. 10.2.

Window “Channel status” cannot be closed during Program work.

Button  “Open files” (Fig. 10.4) duplicates item “Open” of menu “File”, see Subsection 10.2. This button opens dialog window “Select data to be watched”. If this window has been opened before then clicking on button “Open files” will lead to activation of the window.

10.7.3 Control buttons “Print” and “Copy”

Buttons  “Print” and  “Copy” duplicate functions of items “Print” and “Copy” of menu “File”, see Subsection 10.2.



11 Diagrams

To analyze characteristics of signal instability the following diagrams are available in Program:

- “Phase difference”,
- “Relative frequency difference”,
- “Allan variance”,
- “Spectrum”.

These diagrams are described below.

11.1 Diagram “Phase difference”

The sampled differences of phases t_{yx} , t_{zx} , t_{vx} , t_{wx} formed by Time Recorder (see Fig. 11.2) are displayed on this diagram.

To open diagram “Phase difference”, click on item “Phase” in menu “Diagrams”. This command is duplicated by control button  “Phase difference diagram” in dialog window “Select channel to be watched”.

The illustration of diagram “Phase difference” is shown in Fig 11.1. Vertical axis shows magnitudes of sampled (with the accuracy about 10 nanoseconds) signals t_{yx} , t_{zx} , t_{vx} ; t_{wx} (see Section 4), horizontal axis corresponds to the numbers of readouts.

The maximum number of readouts displayed in the diagram is limited by 4000. If length of record exceeds this limit then you can use roll buttons on the top of the diagram to view all data of the record.

Note that real phase difference can be obtained from data shown in the diagram by dividing on multiplier coefficient of Comparator (10^6) and multiplying on 2π .

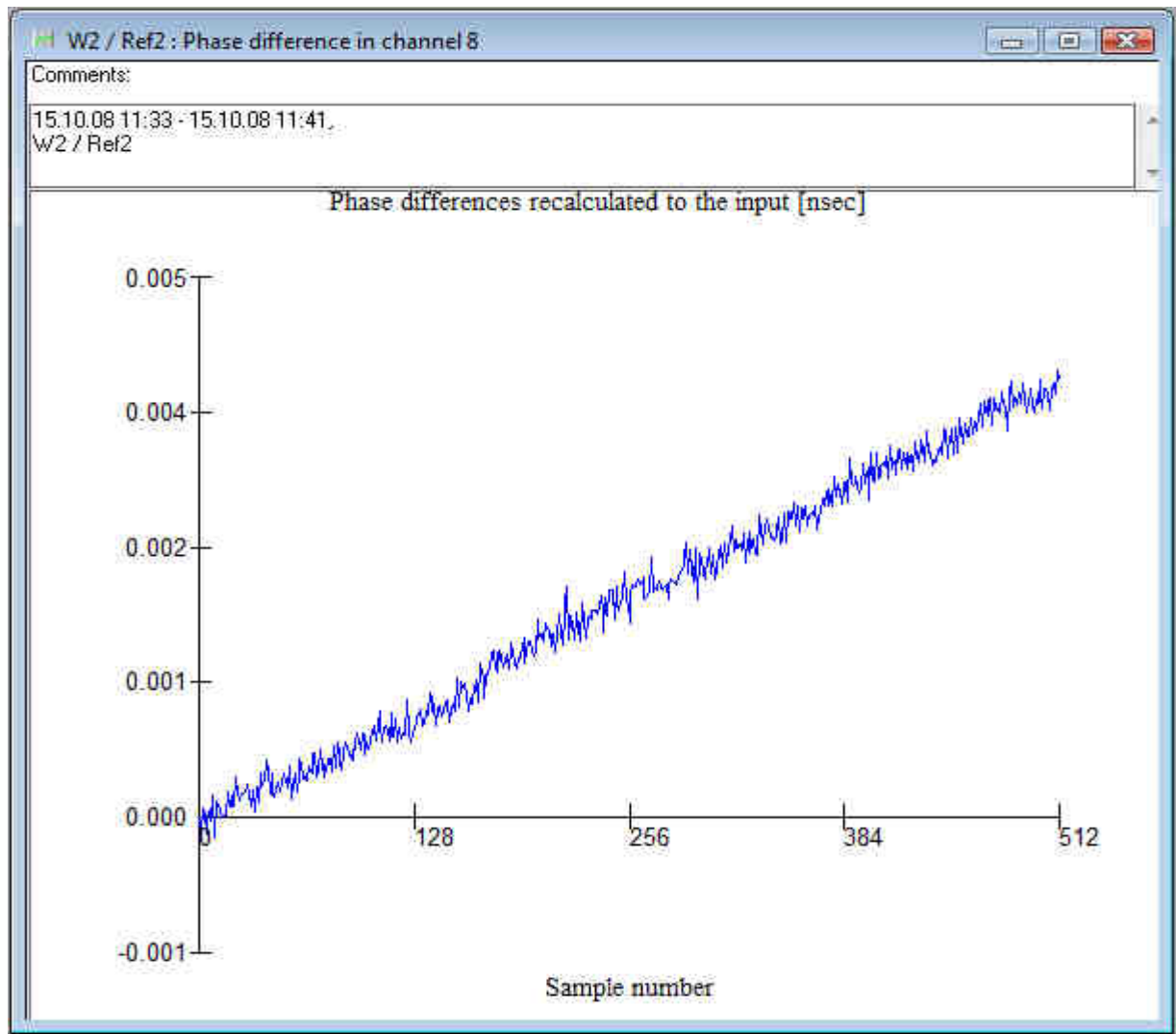

Fig. 11.1 Diagram “Phase difference”

11.2 Diagram “Relative frequency difference”

This diagram displays oscillogram of relative frequency difference. This diagram has a parameter – averaging time. Value of averaging time is presented in window caption and in “Comments” – field of diagram window.

Possible view of the diagram is shown in Fig. 11.2.

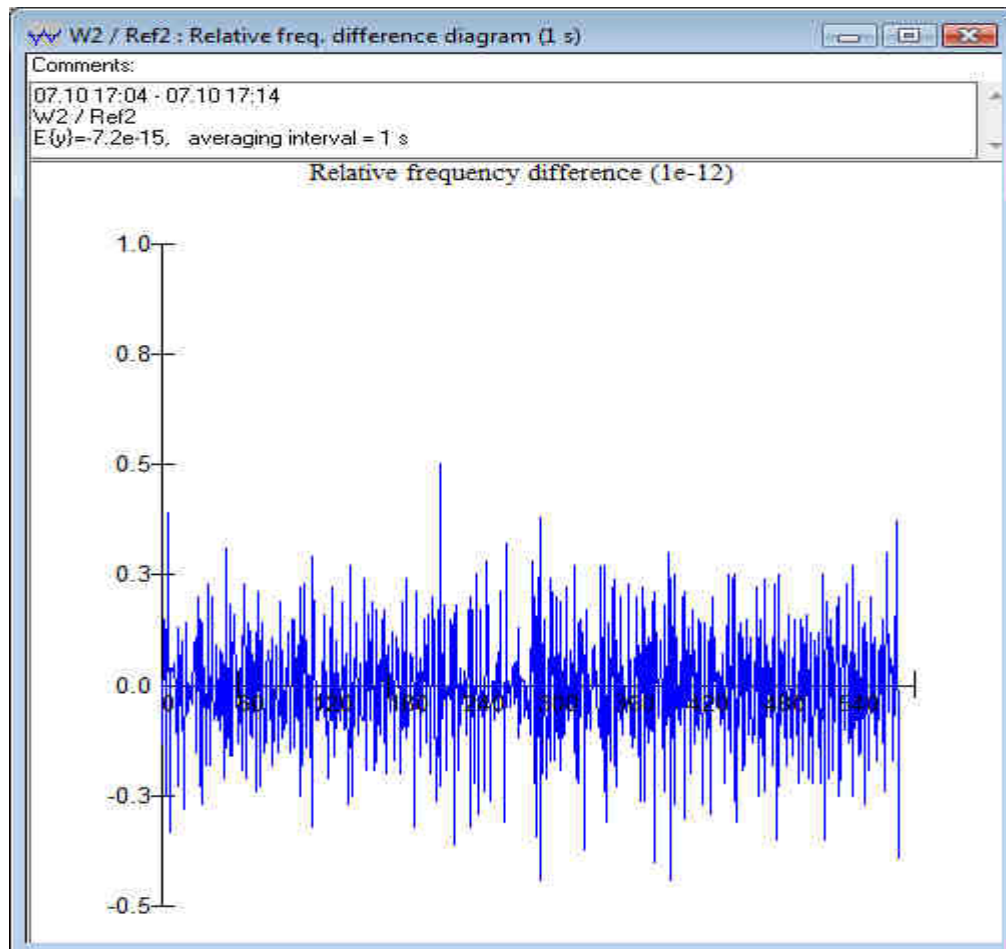



Fig. 11.2 Diagram “Relative frequency difference”

To open diagram “Relative frequency difference”, click on item “Frequency” in menu “Diagrams”. This command is duplicated by control button  “Relative frequency difference diagram” in dialog window “Select channel to be watched”.

Vertical axis corresponds to averaged relative frequency difference, horizontal axis contains sample numbers. The maximum number of displayed points is 4000. If number of points exceeds 4000, then the last 4000 values of relative frequency difference will be displayed in the diagram.

Window caption contains names of reference and tested signals, and averaging time.

Text field “Comments” contains (by default) information about start and end date and time of analyzed record, names of reference and tested signals. It also contains value of average frequency difference $E\{y\}$ and value of averaging time. User can edit this field.

11.3 Diagram “Allan variance”

Diagram “Allan variance” displays statistical function $\text{Var}2$ – root mean square of two-sample relative frequency variance, calculated by the formula (8.5), see Section 8.



To open diagram “Allan variance”, click on item “Variance” in menu “Diagrams”. This command is duplicated by control button  “Allan variance diagram” in dialog window “Select channel to be watched”. Example of this diagram is presented in Fig. 11.3.

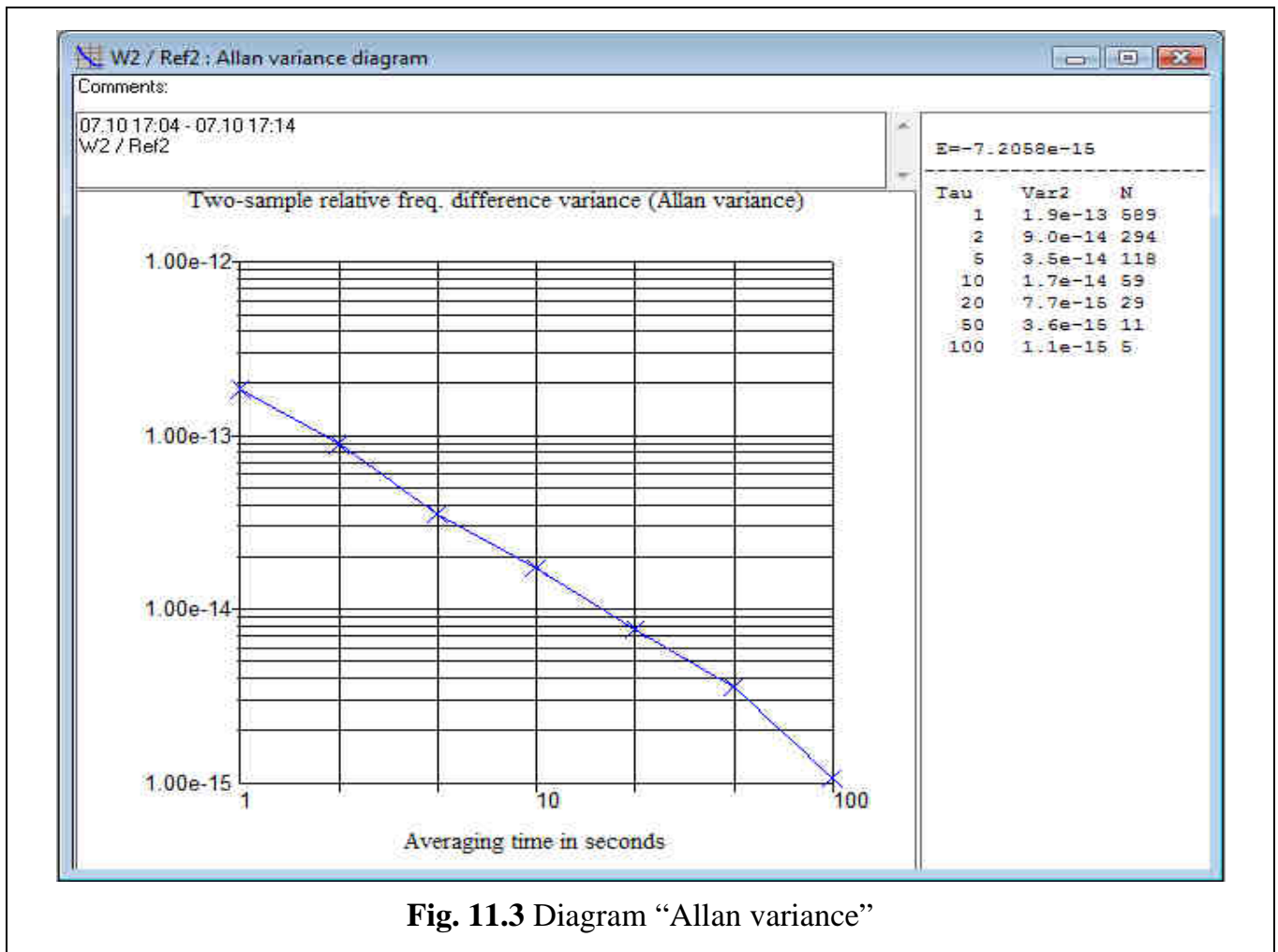



Fig. 11.3 Diagram “Allan variance”

Diagram window contains text field “Comments”, which displays (by default) information about start and end date and time of analyzed record, names of reference and tested signals. User can edit this field.

Right part of the window contains table with available values of Var2 for different averaging times N. On the top of the table average frequency difference $E\{y\}$ is shown.

11.4 Diagram “Spectrum”

To open diagram “Spectrum”, click on item “Spectrum” in menu “Diagrams”. This command is duplicated by control button  “Spectrum diagram” in dialog window “Select channel to be watched”. Example of this diagram is presented in Fig. 11.4.

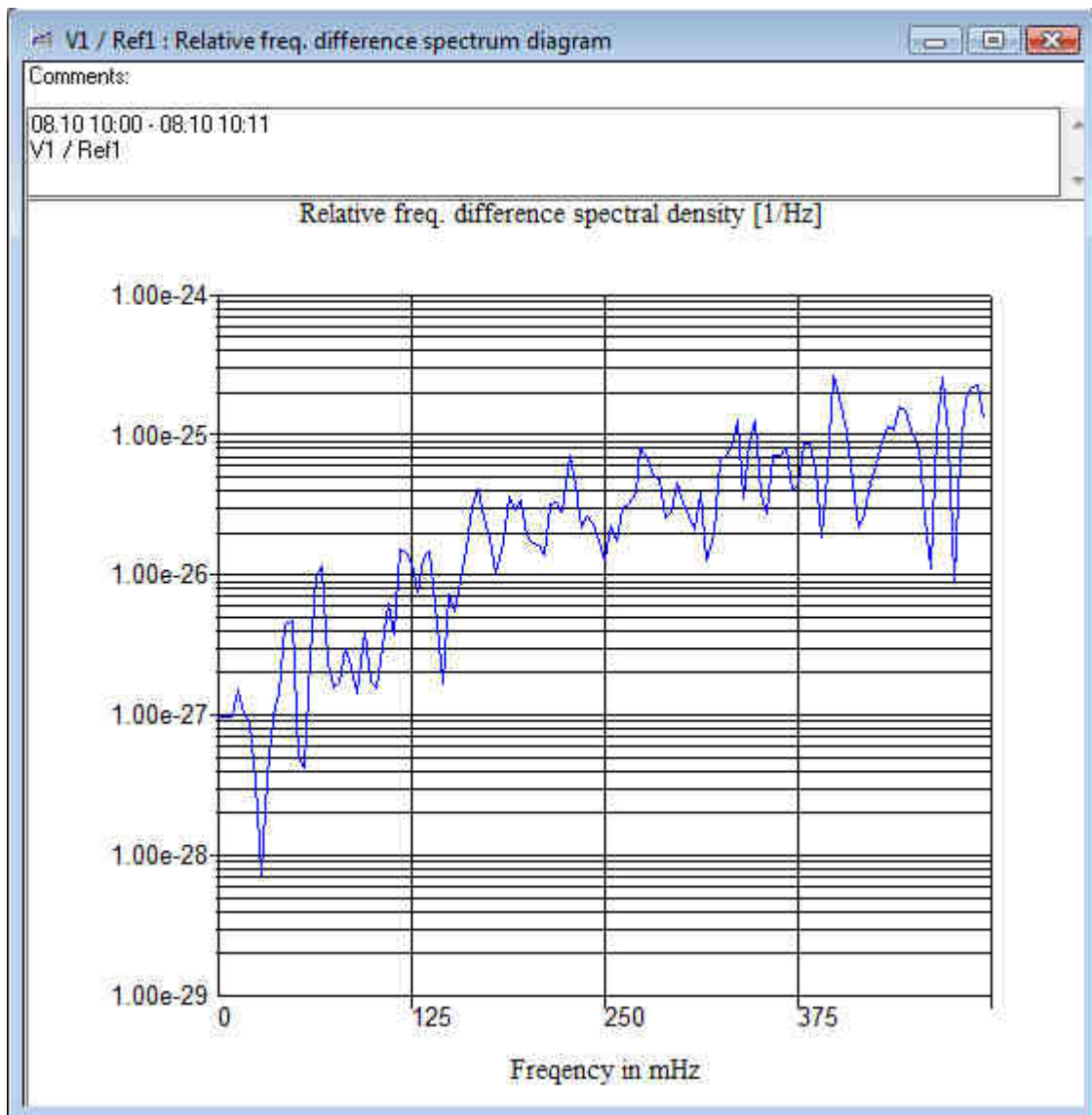



Fig. 11.4 Diagram “Spectrum”

Diagram window contains text field “Comments”, which displays (by default) information about start and end date and time of analyzed record, names of reference and tested signals. User can edit this field.

Field for plot displays spectral density of relative frequency difference. Vertical axis is in logarithmic scale, horizontal axis has linear scale. Frequency on spectrum diagram is presented in [milliHertz].

11.5 Diagram “Allan variance and cross-variance”

To open this diagram, click on the control button  “cross-variances” in dialog window “Select channel to be watched”. Allan variances for frequency differences F_1-F_0 , F_2-F_0 , F_2-F_1 are calculated with formulae (8.5), Allan variances (cross-variances) for single frequen-



cies F0, F1, F2 are calculated with formulae (8.6). Example of this diagram is presented in Fig. 11.45.

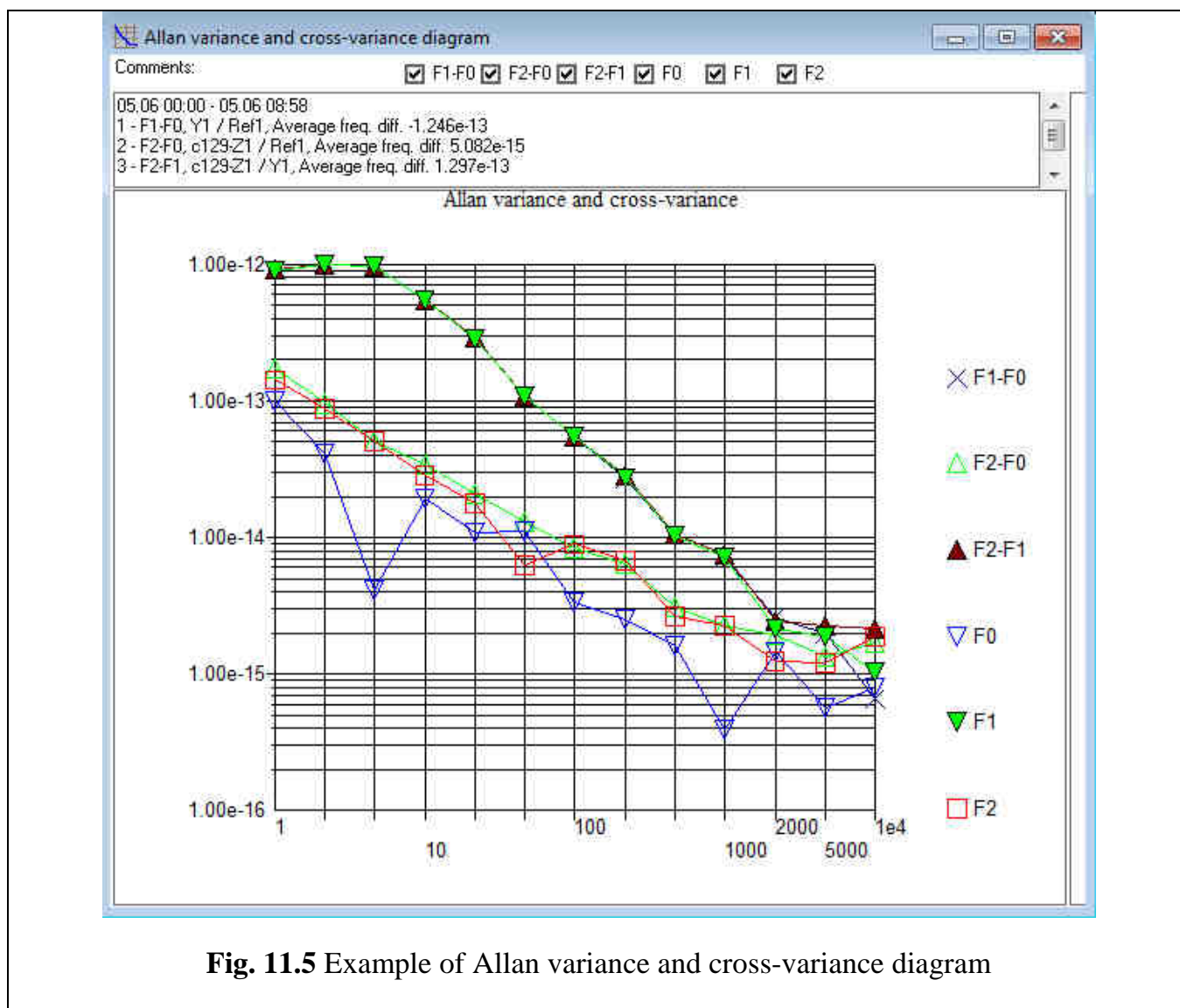

F0 is related to the Allan variance of the reference signal, F1 and F2 corresponds to the measured signals in first and second selected record.

Attention!

Cross-variance calculations for the averaging times 1 - 10 seconds may be inaccurate due to the diversity of phase measurement times in different channels of the comparator. Synchronization errors of phase samples in different channels < 1 second.

If only one Allan variance is selected, then the additional table with the values at different averaging times will be shown (fig. 11.6).

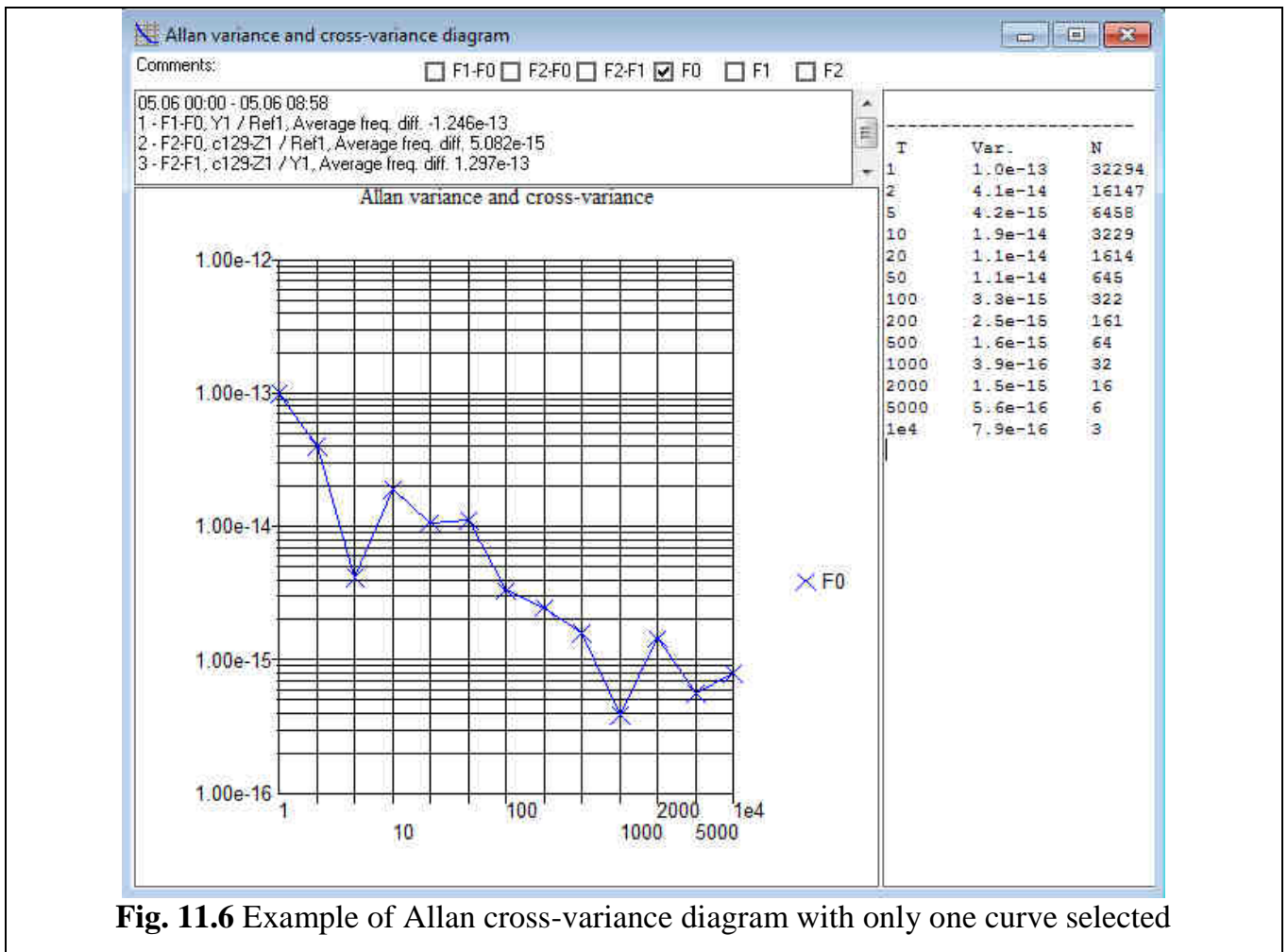

Fig. 11.6 Example of Allan cross-variance diagram with only one curve selected

11.6 Diagram properties

Program allows manipulating the diagrams “Phase difference” and “Relative frequency difference” (change of vertical axis scale, representation of statistical functions, etc.). To open dialog window for manipulation of diagram, click right mouse button on the diagram, see Fig. 11.

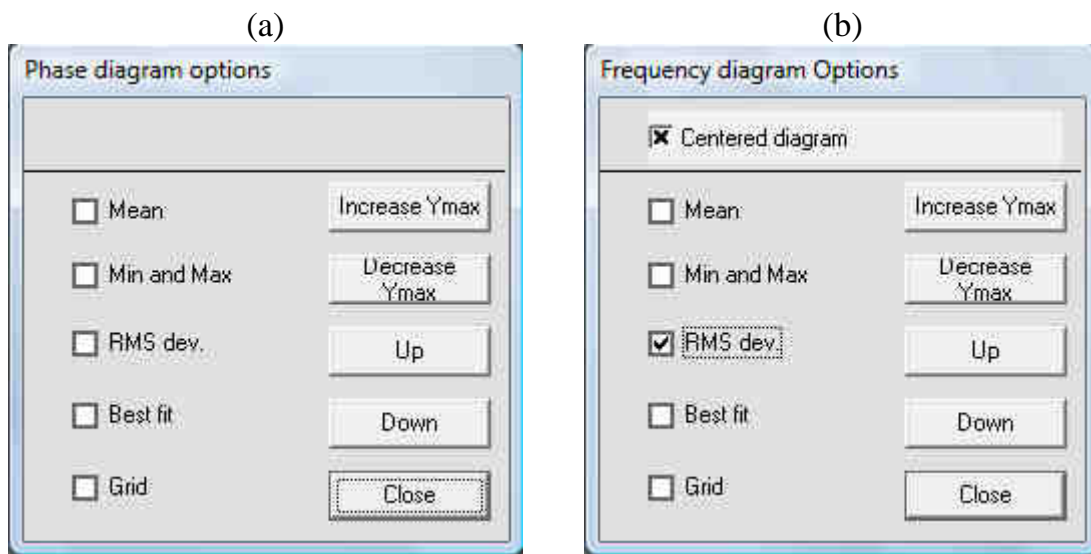

Fig. 11.7 Dialog windows for control of diagrams: (a) “Phase difference” and (b) “Relative frequency difference”

Dialog windows in Fig. 11.7 contain the following check-box and control buttons:

- “Centered diagram” (for diagram “Relative frequency difference” only). Activation of this check-box leads to centering new diagrams.
- “Mean”. Activation of this check-box leads to drawing on the diagram horizontal line corresponding to mean value of data displayed.
- “Min and Max”. Activation of this check-box leads to drawing two horizontal lines corresponding to minimal and maximal values of data displayed.
- “RMS dev.” – root mean square deviation. Activation of this check-box leads to drawing two horizontal lines corresponding to positive and negative RMS deviation of data from mean value.
- “Best fit”. Activation of this check-box leads to drawing the line which corresponds to the best linear approximation of data displayed.
- “Grid”. Activation of this check-box leads to displaying a grid on the diagram.
- “Increase Ymax”. This command doubles the range of values along vertical axis (vertical size of plot is decreased).
- “Decrease Ymax”. This command decreases the range of values along vertical axis in two times.
- “Up”. This command shifts the plot up.
- “Down”. This command shifts the plot down.
- Control button “Close” closes dialog window.